



Features

- Lead free as standard
- RoHS compliant*
- ESD protection
- Protects 2 lines

Applications

- Ethernet - 10/100/1000 Base T
- Firewire and USB
- Portable electronics
- Video/Graphic Cards

CD143A-SR2.8~3.3 – Steering/TVS Diode Array Series

General Information

The CD143A-SR2.8 and CD143A-SR3.3 devices provides ESD protection for the external ports of portable electronic devices such as cell phones, handheld electronics and personal computers.

The ESD protection provided by the component enables a data port to withstand a minimum ± 8 KV Contact / ± 15 KV Air Discharge per the ESD test method specified in IEC 61000-4-2. The device measures 2.80 mm x 1.20 mm and is available in a SOT-143 package intended to be mounted directly onto an FR4 printed circuit board.

The Bourns® device will meet IEC 61000-4-2 (ESD), IEC 61000-4-4 (EFT) and IEC 61000-4-5 (Surge) requirements.

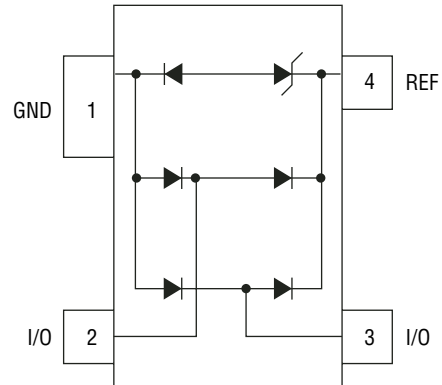

Electrical and Thermal Characteristics (@ $T_A = 25^\circ\text{C}$ Unless Otherwise Noted)

Parameter	Symbol	Value	Unit
Peak Pulse Power ($t_p = 8/20 \mu\text{s}$) ¹	P_{PP}	300	W
Peak Pulse Current ($t_p = 8/20 \mu\text{s}$)	I_{PP}	30	A
Operating Temperature	T_J	-55 °C to 150 °C	°C
Storage Temperature	T_{STG}	-55 °C to 150 °C	°C
Forward Surge Rating (10 mA, 50 μs @ 25 °C)	V_F	1.0	V

Parameter	Symbol	CD143A-SR2.8	CD143A-SR3.3	Unit
Breakdown Voltage Minimum @ 2 μA ²	V_{BR}	3.0	3.5	V
Working Peak Voltage ²	V_{WM}	2.8	3.3	V
Snap-Back Voltage Minimum @ 50 mA	V_{SB}	2.8	3.3	V
Clamping Voltage Maximum @ $I_P = 1 \text{ A}$ ^{2,3}	V_C	5.0	7.0	V
Clamping Voltage Maximum @ I_P ^{2,3}	V_C	8.5 @ 5 A	15 @ 10 A	V
Leakage Current @ V_{WM} ²	I_D	1.0		μA
Capacitance Typical @ 0 V, 1 MHz ⁴	C_J	4.5		pF

Notes:

1. See Peak Pulse Power vs. Pulse Time.
2. From Pin 4 to Pin 1.
3. See Pulse Wave Form.
4. From Pin 1 to Pin 3, Pin 1 to Pin 2, Pin 3 to Pin 4, Pin 2 to Pin 4.

CD143A-SR2.8~3.3 – Steering/TVS Diode Array Series



Product Dimensions

This is a molded JEDEC SOT-143 device. It weighs approximately 35 mg and has a flammability rating of UL 94V-0. The dimensions for the packaged device are shown below.

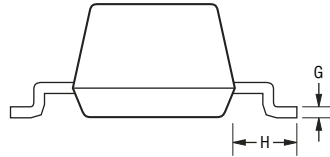
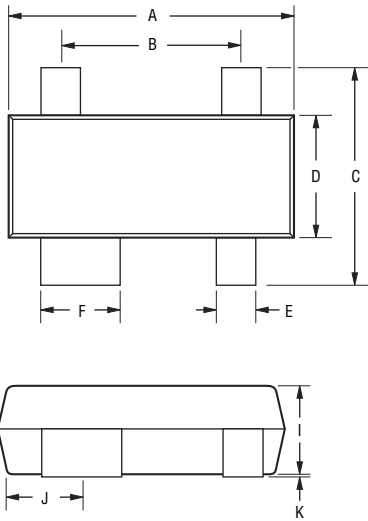

DIMENSIONS: $\frac{\text{MM}}{\text{(INCHES)}}$

Dimensions	
A	$\frac{2.80 - 3.04}{(0.110 - 0.12)}$
B	$\frac{1.78 - 2.03}{(0.070 - 0.080)}$
C	$\frac{2.11 - 2.48}{(0.083 - 0.098)}$
D	$\frac{1.20 - 1.39}{(0.047 - 0.055)}$
E	$\frac{0.39 - 0.50}{(0.015 - 0.020)}$
F	$\frac{0.79 - 0.93}{(0.031 - 0.037)}$
G	$\frac{0.08 - 0.15}{(0.003 - 0.006)}$
H	$\frac{0.46 - 0.60}{(0.018 - 0.024)}$
I	$\frac{0.84 - 1.14}{(0.033 - 0.045)}$
J	$\frac{0.72 - 0.83}{(0.028 - 0.033)}$
K	$\frac{0.013 - 0.10}{(0.0005 - 0.004)}$

Recommended Pad Layout

This is the footprint recommended for this SOT-143 device.

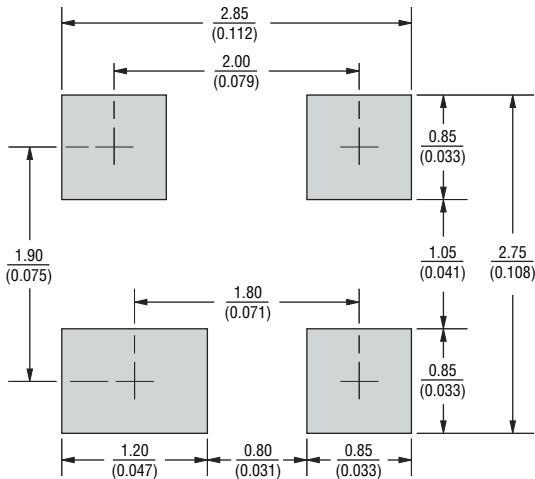

DIMENSIONS: $\frac{\text{MM}}{\text{(INCHES)}}$

Block Diagram

The device block diagram below includes the pin names and basic electrical connections associated with each channel.

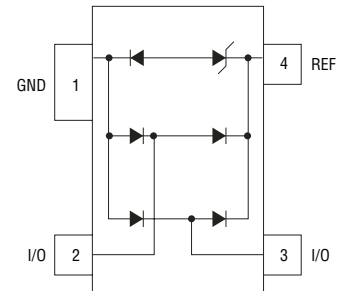

Typical Part Marking

CD143A-SR2.82A
 CD143A-SR3.33A

CD143A-SR2.8~3.3 – Steering/TVS Diode Array Series



Performance Graphs

Peak Pulse Power vs Pulse Time

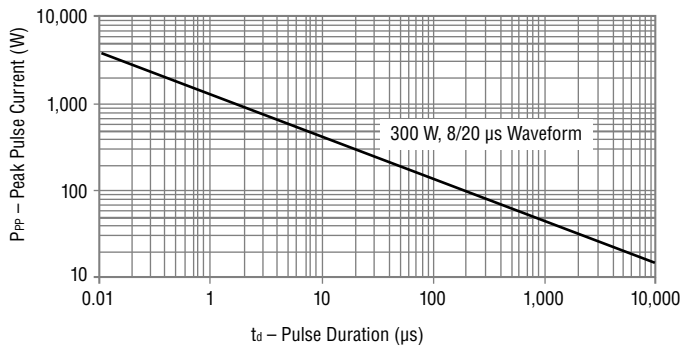

Pulse Wave Form

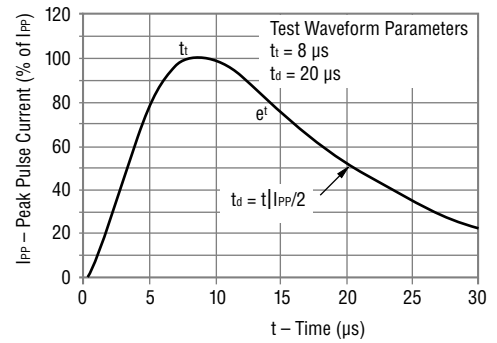

How To Order

CD 143A - SR 2.8

- Common Code _____
- Chip Diode _____
- Package _____
- 143A = SOT-143
- Model _____
- SR = Steering Diode Array
- Repetitive Peak Reverse Voltage _____
- 2.8 = 2.8 V_{RWM} (Volts)
- 3.3 = 3.3 V_{RWM} (Volts)

Specifications are subject to change without notice.
 Customers should verify actual device performance in their specific applications.

CD143A-SR2.8~3.3 – Steering/TVS Diode Array Series

BOURNS®

Packaging Information

The surface mount product is packaged in an 8 mm x 4 mm tape and reel format per EIA-481 standard.

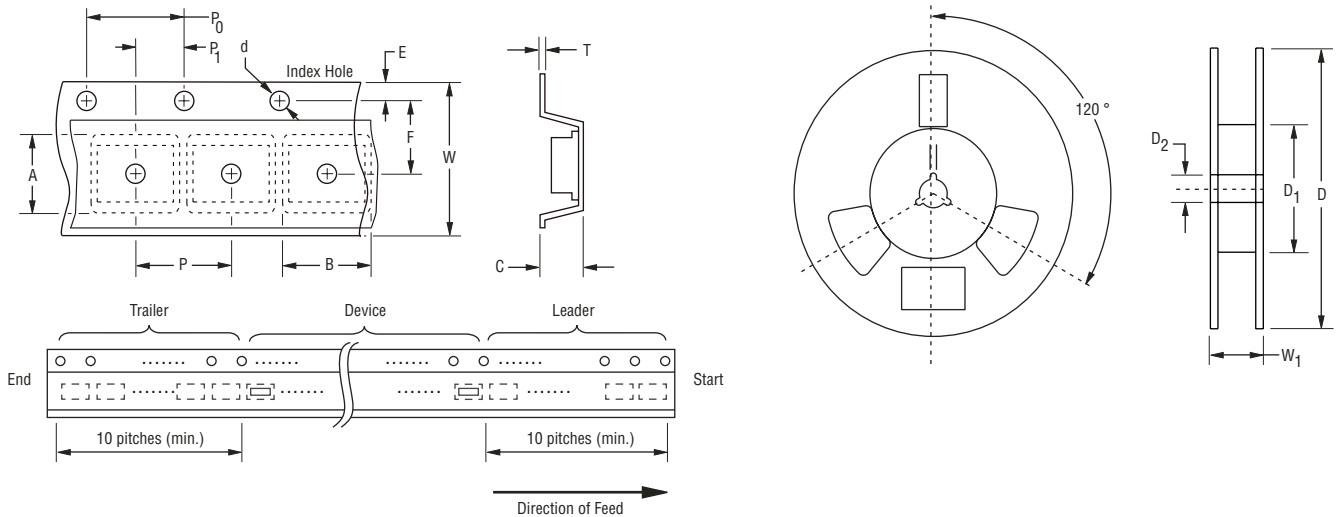

Item	Symbol	SOT-143
Carrier Width	A	$\frac{2.75 \pm 0.10}{(0.108 - 0.004)}$
Carrier Length	B	$\frac{3.30 \pm 0.10}{(0.130 - 0.004)}$
Carrier Depth	C	$\frac{1.25 \pm 0.10}{(0.049 - 0.004)}$
Sprocket Hole	d	$\frac{1.55 \pm 0.05}{(0.061 - 0.002)}$
Reel Outside Diameter	D	$\frac{178}{(7.008)}$
Reel Inner Diameter	D ₁	$\frac{50.0}{(1.969)}$ Min.
Feed Hole Diameter	D ₂	$\frac{13.0 \pm 0.20}{(0.512 - 0.008)}$
Sprocket Hole Position	E	$\frac{1.75 \pm 0.10}{(0.069 - 0.004)}$
Punch Hole Position	F	$\frac{3.50 \pm 0.05}{(0.138 - 0.002)}$
Punch Hole Pitch	P	$\frac{4.00 \pm 0.10}{(0.157 - 0.004)}$
Sprocket Hole Pitch	P ₀	$\frac{4.00 \pm 0.10}{(0.157 - 0.004)}$
Embossment Center	P ₁	$\frac{2.00 \pm 0.05}{(0.079 - 0.002)}$
Overall Tape Thickness	T	$\frac{0.20 \pm 0.10}{(0.008 - 0.004)}$
Tape Width	W	$\frac{8.00 \pm 0.20}{(0.315 - 0.008)}$
Reel Width	W ₁	$\frac{14.4}{(0.567)}$ Max.
Quantity per Reel	—	3,000



Asia-Pacific:

Tel: +886-2 2562-4117 • Fax: +886-2 2562-4116

Europe:

Tel: +41-41 768 5555 • Fax: +41-41 768 5510

The Americas:

Tel: +1-951 781-5500 • Fax: +1-951 781-5700

www.bourns.com